

# SPECIFICATIONS

RATED VOLTAGE	3.0 Vo-p
OPERATING VOLTAGE RANGE	2.0 ~ 4.0 Vo-p
RATED FREQUENCY	4,000 Hz
MAX CURRENT CONSUMPTION	MAX 100 mA
COIL RESISTANCE	12 +/- 3 Ohms
MIN. SOUND LEVEL AT 10cm	MIN 78 dBA
HOUSING MATERIAL	NYLON #46
PLATING MATERIAL	GOLD PLATED BRASS

# REVISIONS

NO.	CONTENTS	DATE	MADE BY
1	INITIAL RELEASE	13 SEP	D.KIM

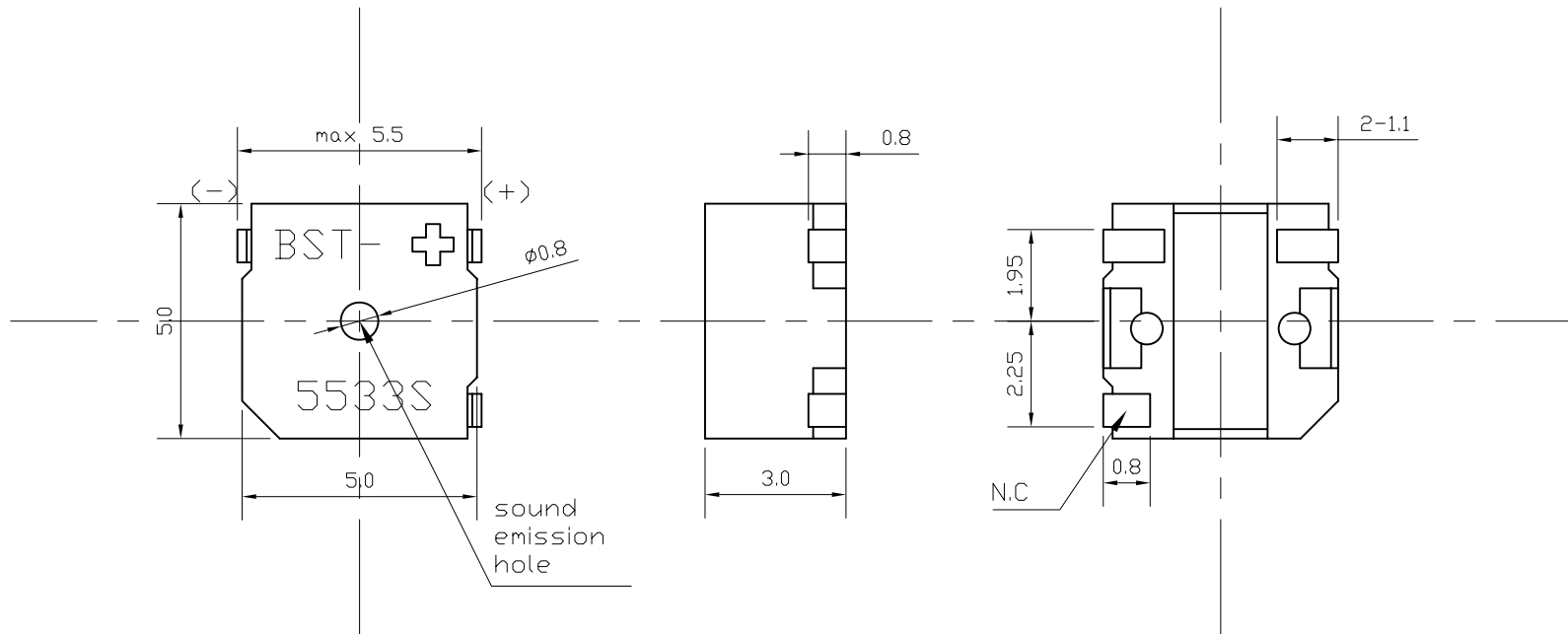

**\*NOTES**

- ALL DIMENSIONS ARE IN MILLIMETERS
- ROHS COMPLIANT
- GENERAL TOLERANCE : 0.2MM

SIZE A4	SPECIFICATION SUBJECT TO CHANGE OR WITHDRAWAL WITHOUT PRIOR NOTICE	 WWW.BOSANHITECH.COM
DRAWN BY : S.KIM	DATE SEP '10	
APPROVED BY : D.KIM	DATE SEP '10	P/N : BST-5533S (SMT MAGNETIC TRANSDUCER)
		THIS DRAWING IS PROPERTY OF BOSANHITECH. DO NOT DUPLICATE WITHOUT PERMISSION